

8A, 600V Ultrafast Single Diode

Features

- Ultrafast recovery time $t_r < 23\text{ns}$
- Low forward voltage drop
- Low leakage current
- High reliability by planer design
- Maximum Junction Temperature Range(150°C)

General Description

Winsemi's FRD.. series are the state of the are Ultra fast recovery rectifiers specifically designed with optimized performance of forward voltage drop and ultra fast recovery time The planar structure and the platinum doped life time control, guarantee the best overall performance, ruggedness and reliability characteristics.

Applications

- Freewheeling, Snubber, Clamp
- Inversion Welder
- PFC
- Plating Power Supply
- Ultrasonic Cleaner and Welder
- Converter & Chopper
- UPS

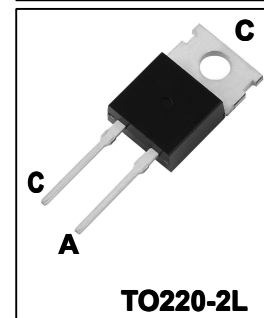
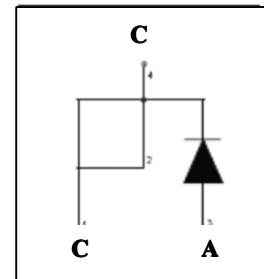

Absolute Maximum Ratings

Symbol	Parameter	Value	Units
V_{RRM}	Peak Repetitive Reverse Voltage	600	V
$I_{F(AV)}$	Average Forward Current Square wave, duty=1/2, $T_c=115^\circ\text{C}$	8	A
I_{FM}	Repetitive Peak Forward Current Square wave, 20kHz, $T_c=115^\circ\text{C}$	16	A
I_{FSM}	No-Repetitive Peak Surge Current	110	A
P_D	Power Dissipation	50	W
T_{STG}, T_J	Operating Junction Temperature & Storage Temperature	-40 to 150	$^\circ\text{C}$
Torque	Module-to-Sink, Recommended (M3)	1.1	N.m

Electrical Characteristics ($T_c=25^\circ\text{C}$ unless otherwise noted)

Symbol	Parameter	Test Conditions	Value			Units
			Min	Typ	Max	
V_F	Forward Voltage Drop	$I_F=8\text{A}$	-	1.4	1.7	V
		$I_F=16\text{A}$	-	1.7	2.1	V
I_{RRM}	Reverse Current	$V_R=600\text{V}$	-	-	15	μA
		$V_R=600\text{V}, T_c=150^\circ\text{C}$	-	-	500	μA
t_r	Reverse Recovery Time	$I_F=1.0\text{A}, V_R=30\text{V}, di_F/dt=50\text{A}/\mu\text{s}$	-	17	23	ns
		$I_F=8.0\text{A}, V_R=300\text{V}$	-	30	-	
$R_{th(J-C)}$	Thermal Resistance		-	-	2.5	$^\circ\text{C}/\text{W}$

Typical Performance Curves

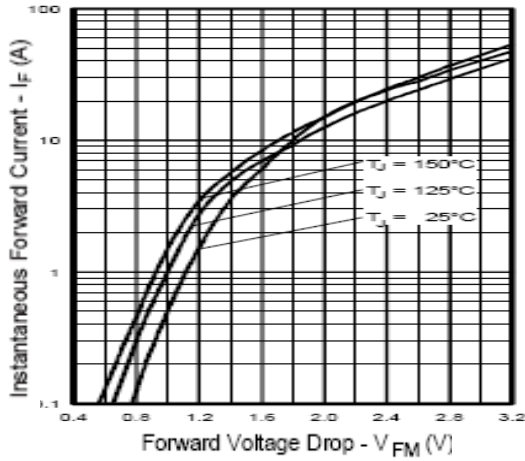

Fig.1 Forward Characteristics

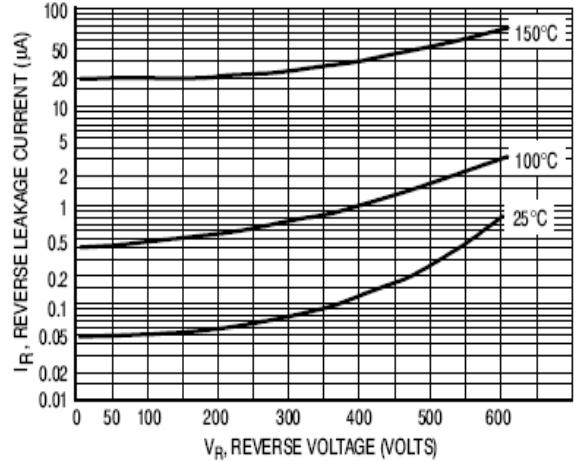

Fig.2 Reverse Characteristics

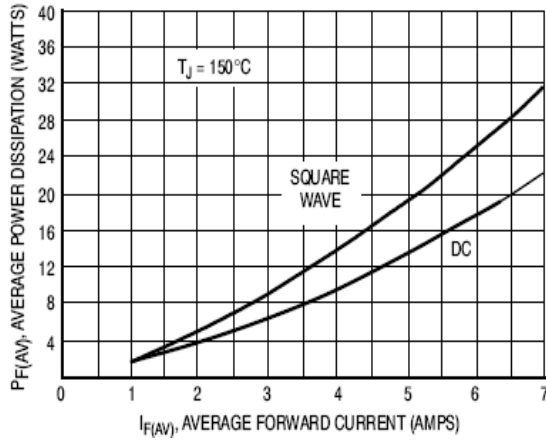

Fig.3 Forward Power Dissipation

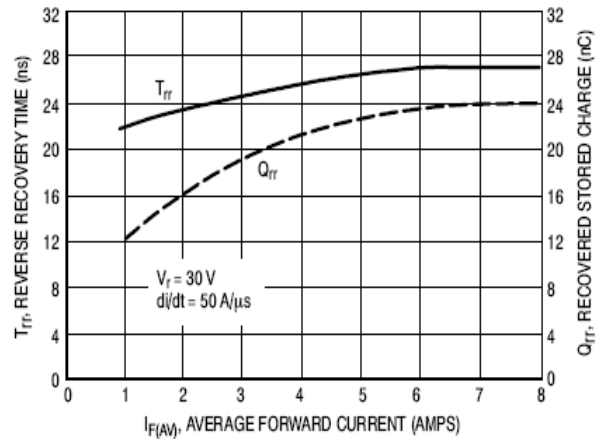

Fig.4 Recovery Characteristics

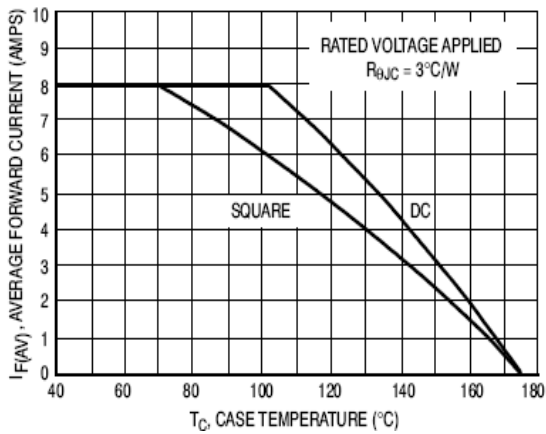

Fig.5 Out Current VS Case Temperature

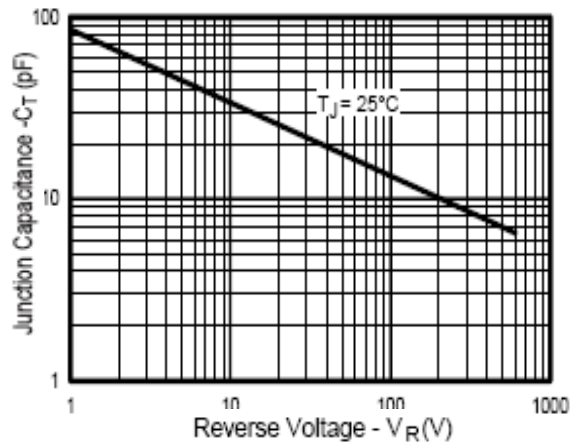

Fig.6 Junction Capacitance VS Reverse Voltage

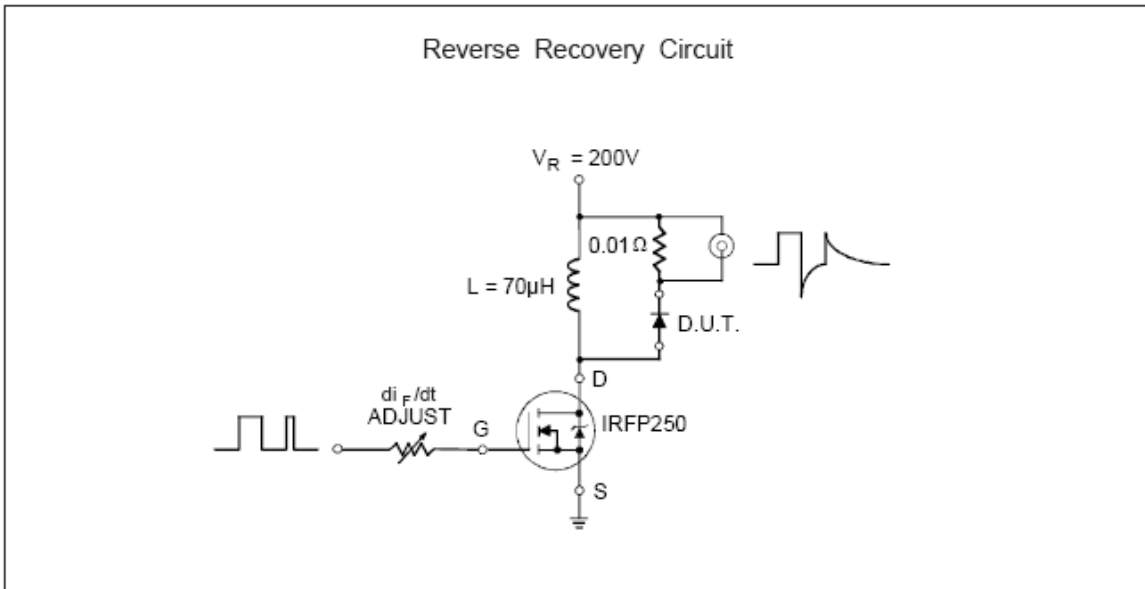

Fig.7 Reverse Recovery Parameter Test Circuit

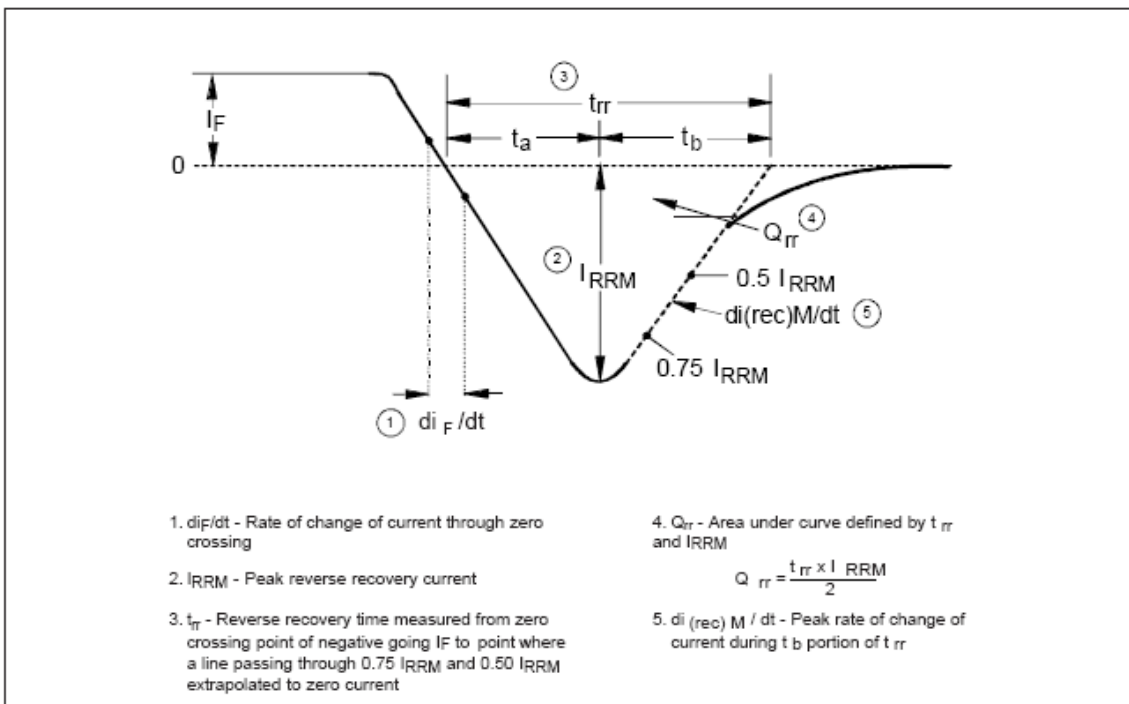

Fig.8 Reverse Recovery Waveform and Definitions

TO220-2L Package Dimension

