

Features

- Ultra low R_{dson}
- Ultra low gate charge (typ. $Q_g = 13nC$)
- 100% UIS tested
- RoHS compliant

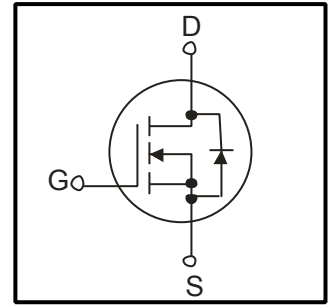

General Description

Power MOSFET is fabricated using advanced super junction technology. The resulting device has extremely low on resistance, making it especially suitable for applications which require superior power density and outstanding efficiency.

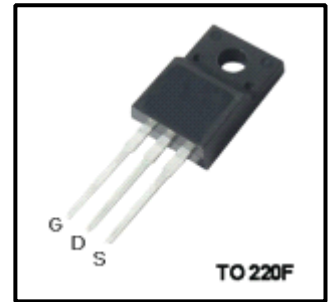

Absolute Maximum Ratings

Symbol	Parameter	Value	Units
V_{DSS}	Drain Source Voltage	650	V
I_D	Continuous Drain Current ($T_c=25^\circ C$) ($T_c=100^\circ C$)	4	A
		2.5	
I_{DM}	Drain Current Pulsed ¹⁾	12	A
V_{GS}	Gate to Source Voltage	± 30	V
E_{AS}	Single Pulse Avalanche Energy ²⁾	130	mJ
I_{AR}	Single Pulse Avalanche Current ¹⁾	4	A
E_{AR}	Repetitive Avalanche Energy ¹⁾	0.4	mJ
P_D	Total Power Dissipation (@ $T_c=25^\circ C$) -Derate above $25^\circ C$	29	W
		0.23	W/ $^\circ C$
T_J	Junction Temperature	150	$^\circ C$
T_{stg}	Storage Temperature	-55~150	$^\circ C$
I_S	Continuous diode forward current	4	A
$I_{S,pulse}$	Diode pulse current	12	A

Notes:

- 1.Repetitive Rating:Pulse width limited by maximum Junction Temperature
2. $I_{AS}=2A, V_{DD}=60V, R_G=25\Omega, Starting T_J=25^\circ C$

Thermal Characteristics

Symbol	Parameter	Value			Units
		Min	Typ	Max	
R_{QJC}	Thermal Resistance , Junction -to -Case	-	-	4.3	$^\circ C/W$
R_{QJA}	Thermal Resistance , Junction-to-Ambient	-	-	80	$^\circ C/W$

Electrical Characteristics(Tc=25°C unless otherwise noted)

Characteristics	Symbol	Test Condition	Min	Type	Max	Unit
Gate leakage current	I_{GSS}	$V_{GS}=\pm 30V, V_{DS}=0V$	-	-	± 100	nA
Drain cut-off current	I_{DSS}	$V_{DS}=650, V_{GS}=0V,$ $T_J=25^\circ C$ $T_J=125^\circ C$	-	-	1	μA
			-	10	-	
Drain -source breakdown voltage	$V_{(BR)DSS}$	$I_D=250\mu A, V_{GS}=0V$	650	-	-	V
Gate threshold voltage	$V_{GS(th)}$	$V_{DS}=V_{GS}, I_D=250\mu A$	2.5	3.5	4.5	V
Drain -source ON resistance	$R_{DS(ON)}$	$V_{GS}=10V, I_D=2A$ $T_J=25^\circ C$ $T_J=150^\circ C$	-	0.83	0.93	Ω
			-	1.9	-	
Gate resistance	R_G	f=1MHz, open drain	-	0.4	-	Ω
Input capacitance	C_{iss}	$V_{DS}=25V,$ $V_{GS}=0V,$ f=1MHz	-	450		pF
Reverse transfer capacitance	C_{rss}		-	5		
Output capacitance	C_{oss}		-	300		
Turn-on delay time	$t_d(on)$	$V_{DD} = 300V, I_D = 2A$ $R_G = 12\Omega, V_{GS}=10V$	-	13	-	ns
Rise time	t_r		-	12	-	
Turn-off delay time	$t_d(off)$		-	31	-	
Fall time	t_f		-	9	-	
Gate to source charge	Q_{gs}	$V_{DD}=480V, I_D=2A,$ $V_{GS}=0$ to 10 V	-	3	-	nC
Gate to drain charge	Q_{gd}		-	6	-	
Gate charge total	Q_g		-	13	-	
Gate plateau voltage	$V_{plateau}$		-	5.8	-	

Source-Drain Ratings and Characteristics(Ta=25°C)

Characteristics	Symbol	Test Condition	Min	Type	Max	Unit
Diode forward voltage	V_{SD}	$V_{GS}=0V, I_F=2A$	-	-	1.2	V
Reverse recovery time	t_{rr}	$V_R=50V, I_F=4A,$ dI _F /dt=100 A/ μ s	-	220	-	ns
Reverse recovery charge	Q_{rr}		-	1.6	-	μc
Peak reverse recovery current	I_{rrm}		-	12	-	A

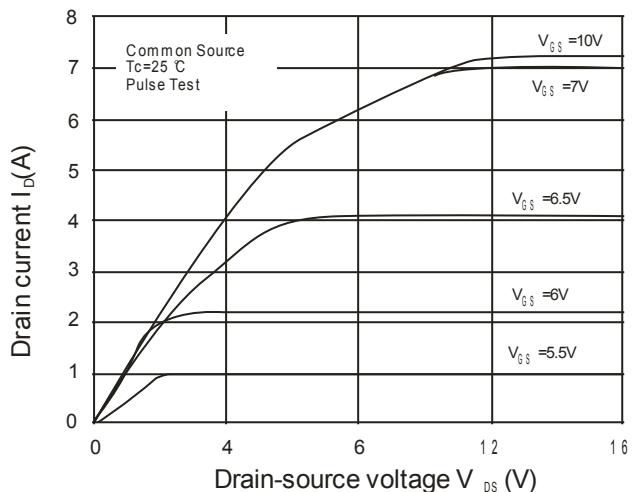

Fig.1 On-Region characteristics

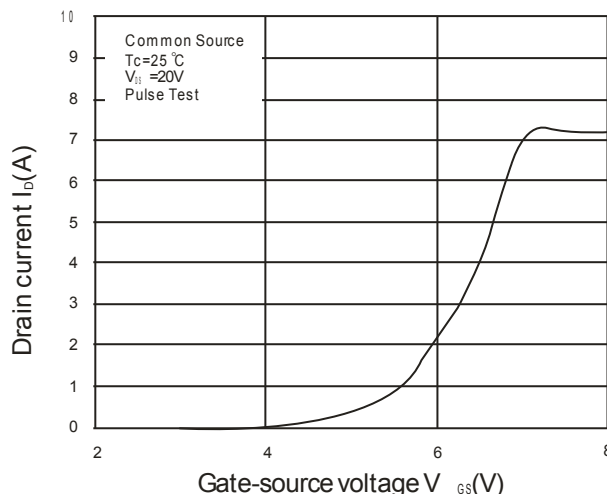

Fig.2 Transfer characteristics

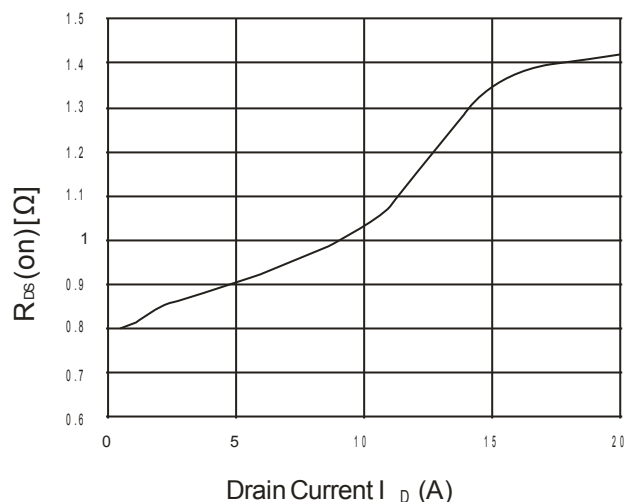

Fig.3 On-Resistance Variation vs Drain Current

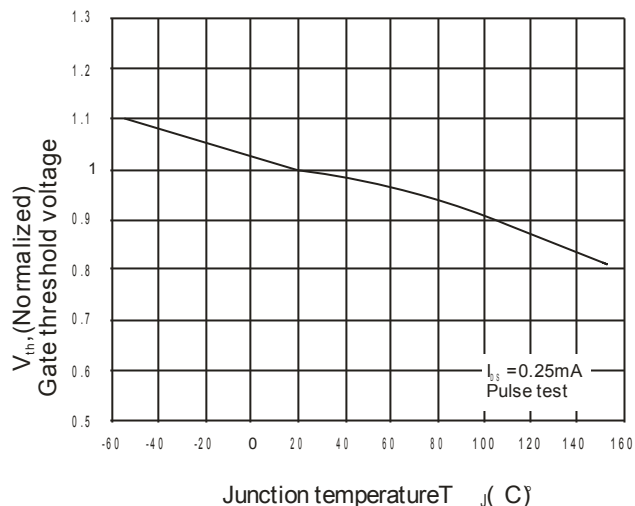

Fig.4 Threshold Voltage vs. Temperature

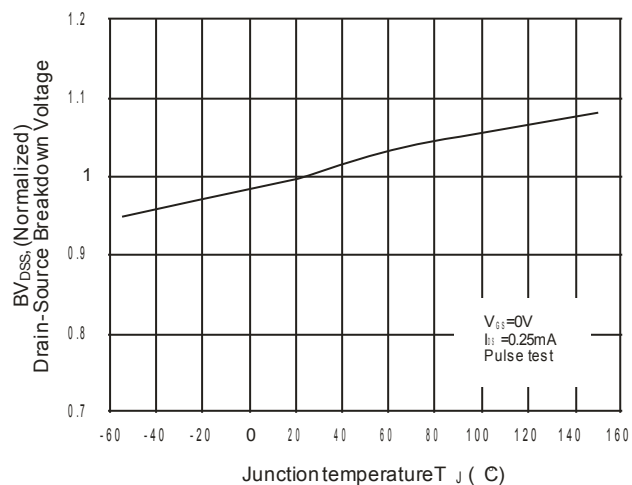

Fig.5 Breakdown Voltage vs. Temperature

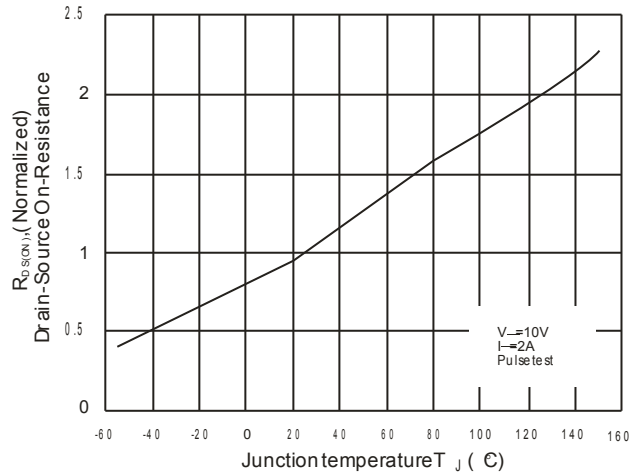

Fig.6 On-Resistance vs. Temperature

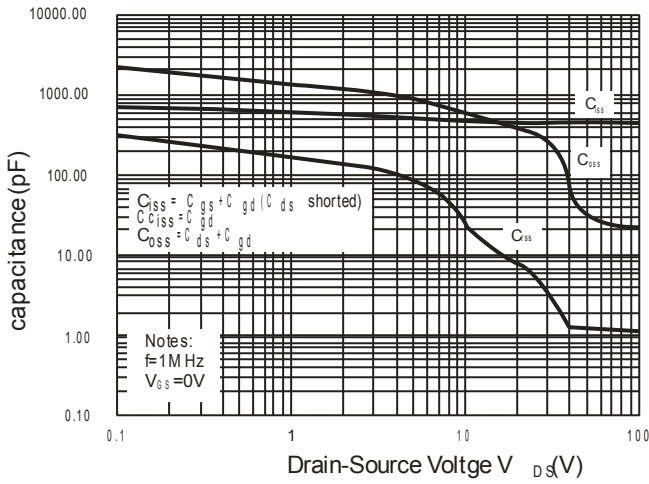

Fig.7 Capacitance Characteristics

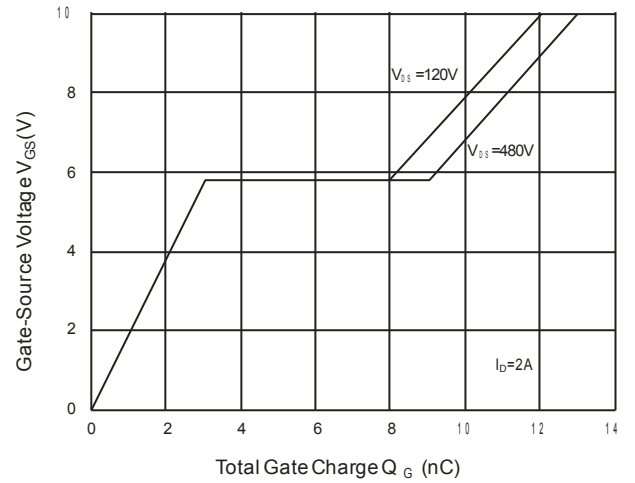

Fig.8 Gate Charge Characteristics

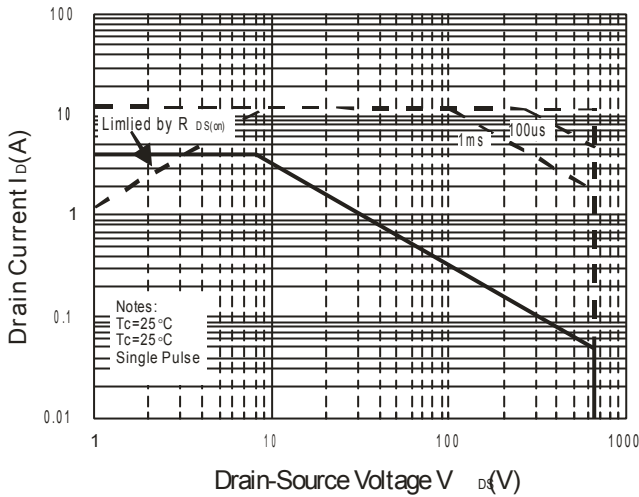

Fig.9 Maximum Safe Operation Area

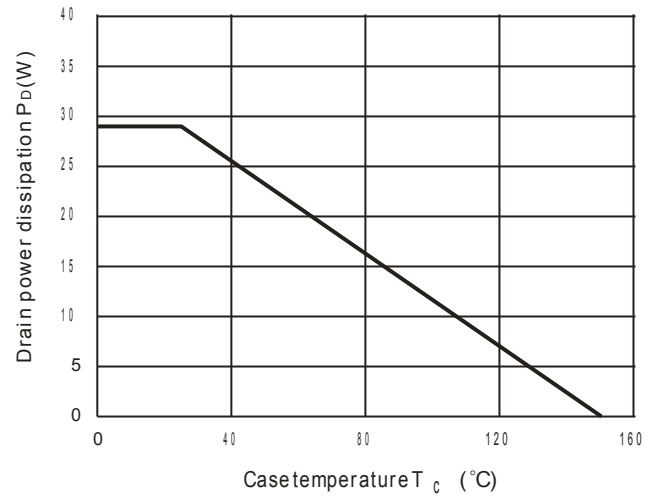

Fig.10 Power Dissipation vs. Temperature

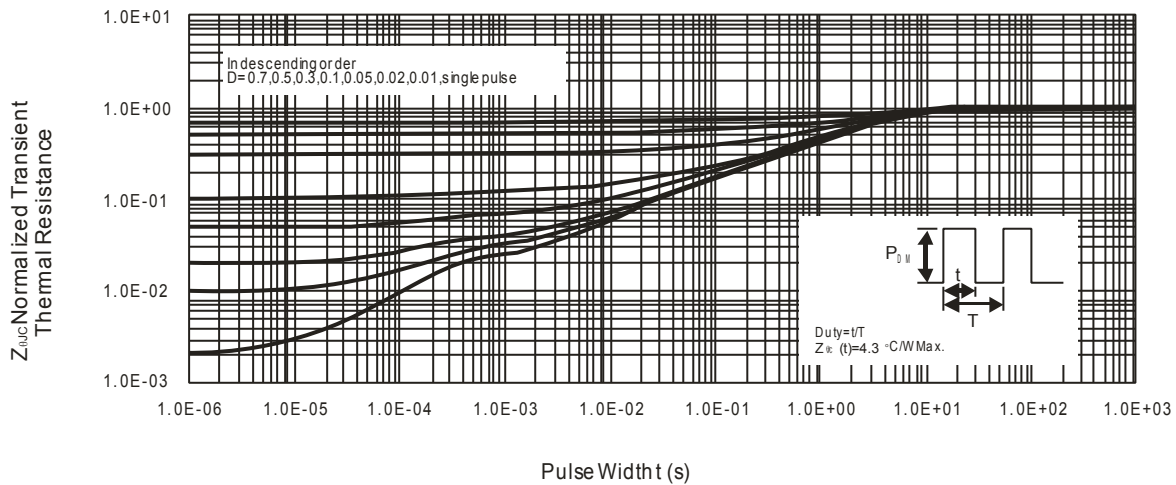

Fig.11 Transient Thermal Response Curve

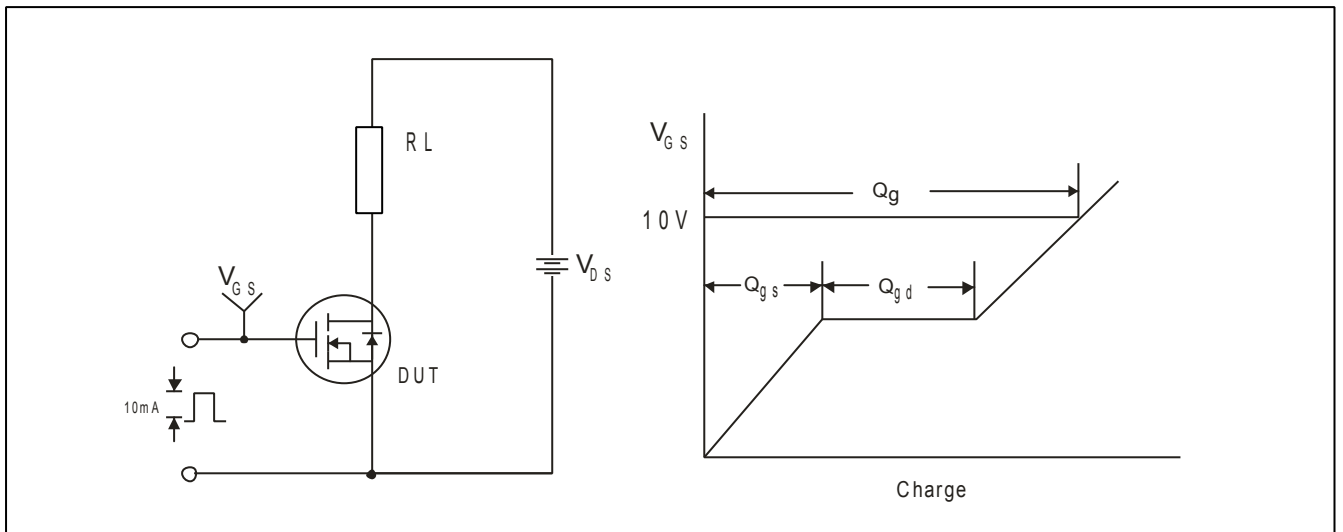

Fig.12 Gate Charge Test Circuit & Waveform

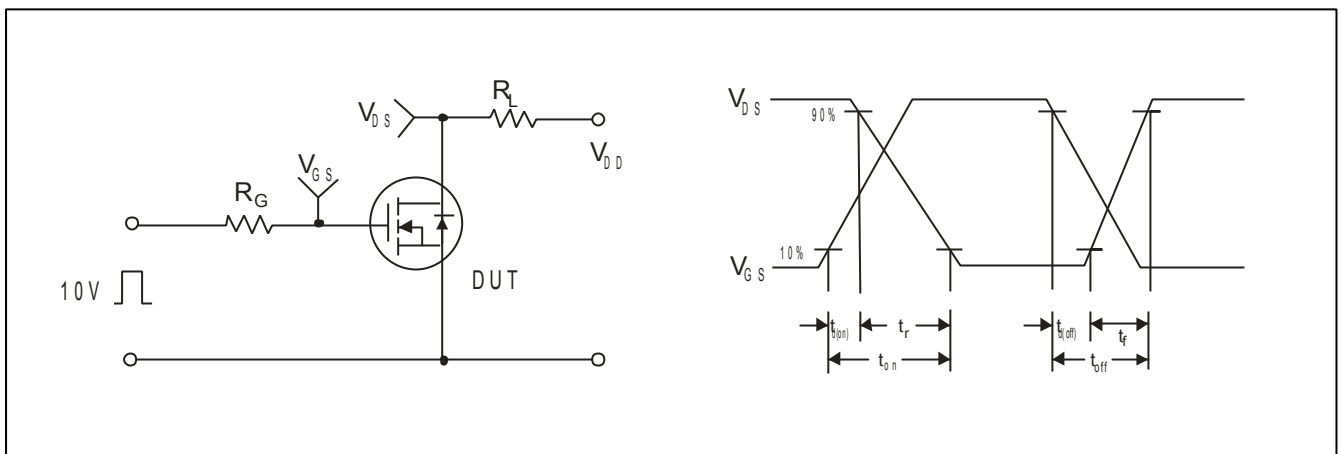

Fig.13 Switching Test Circuit & Waveforms

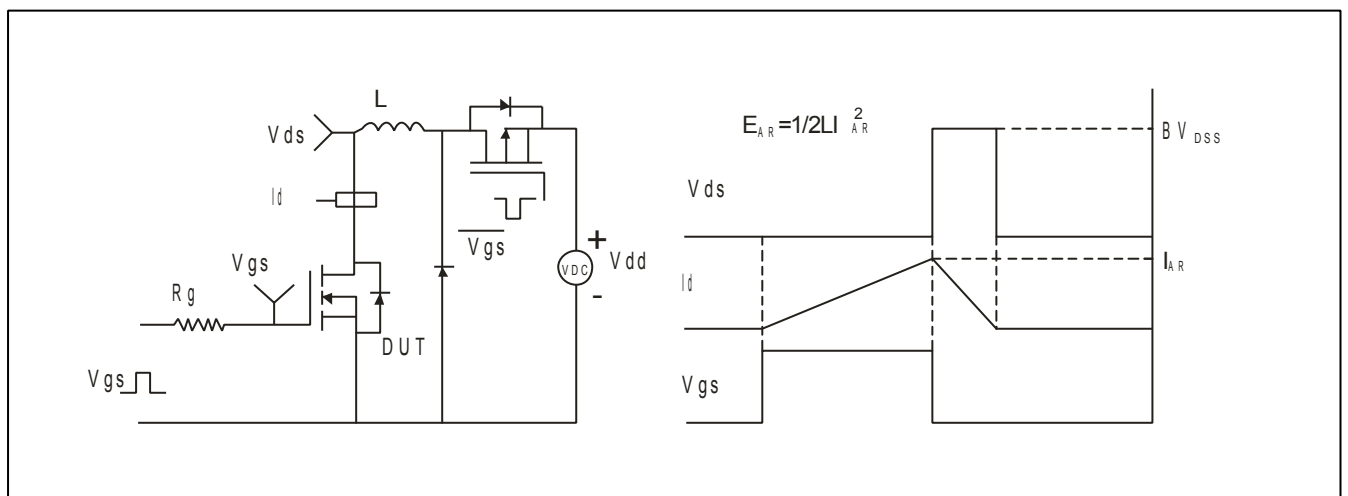
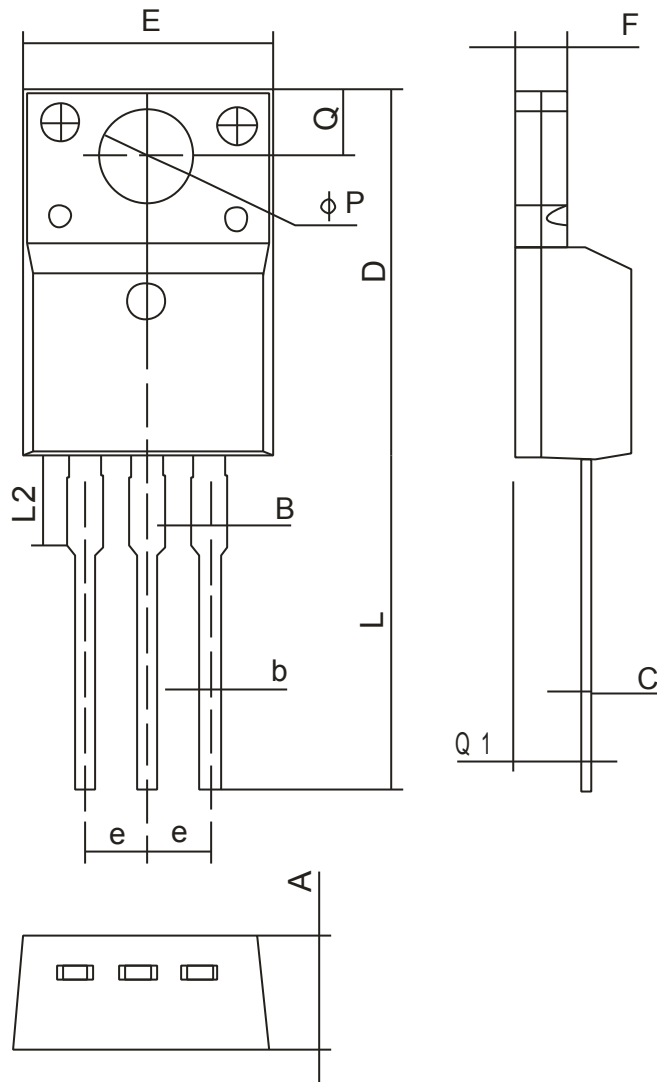

Fig.14 Unclamped Inductive Switching Test Circuit & Waveform

TO220F Package Dimension

Unit:mm



符号 Symbol	MIN	MAX
A	4.5	4.9
B	-	1.47
b	0.7	0.9
c	0.45	0.6
D	15.67	16.07
E	9.96	10.36
e	2.54TYP.	
F	2.34	2.74
L	12.58	13.38
L2	3.13	3.33
ϕP	3.08	3.28
Q	3.2	3.4
Q1	2.56	2.96

NOTE:

1. We strongly recommend customers check carefully on the trademark when buying our product, if there is any question, please don't be hesitate to contact us.
2. Please do not exceed the absolute maximum ratings of the device when circuit designing.
3. Winsemi Microelectronics Co., Ltd reserved the right to make changes in this specification sheet and is subject to change without prior notice.

CONTACT:

Winsemi Microelectronics Co., Ltd.

ADD: Futian District, ShenZhen Tian An Cyber Tech Plaza two East Wing 1002

Post Code : 518040

Tel : 86-0755-82506257

FAX : 86-0755-82506299

Web Site : www.winsemi.com